

Conecto Dowel
 10NA40-5D-T8 h=125
 galvanized steel version
 SECTION
 SCALE 2:1

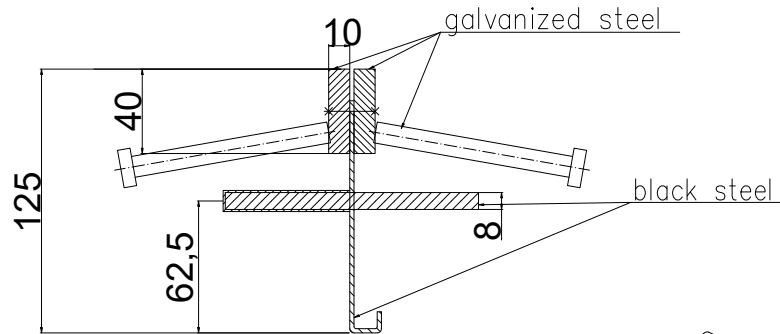

Conecto Dowel
 10NA40-5D-T8 h=125
 galvanized steel version
 VIEW

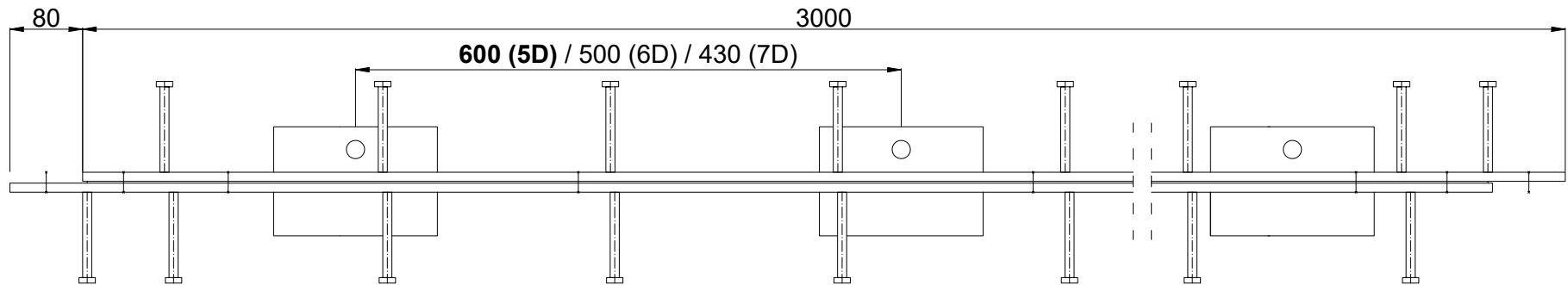
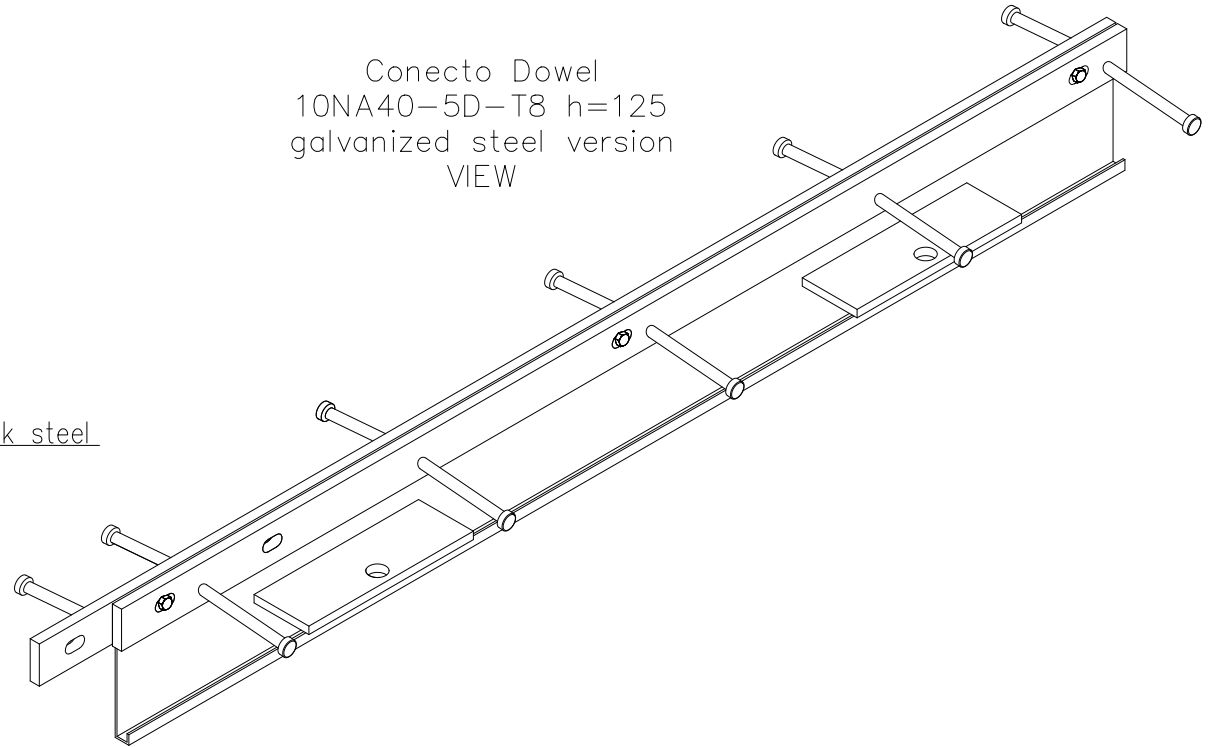

Conecto Dowel
 10NA40-5D-T8 h=125 PC
 L=3000, galvanized steel version

All dimensions in [mm] REV 1.2
 Rysunek i wszystkie informacje, które zawiera są własnością firmy Conecto Profiles Sp. z o.o.. Powielanie w jakiegokolwiek postaci całości, bądź części rysunku wymaga pisemnej zgody właściciela.
 This drawing and all information contained there in, is the property of Conecto Profiles Ltd. Reproduction of this drawing in whole or part, or disclosure to a third part is not permitted without written authorization from the proprietor.



Conecto Profiles Sp. z o.o.
 ul. Przemysłowa 39
 61-541 Poznań
 +48 62 763 29 44

email: office@conecto-profiles.com

www: www.conecto-profiles.com