

INFORMATION TABLE

Profile type	Visible element [mm]	Joint width [mm]	Base width [mm]	Installation height [mm]	Material type	Maximum load [kN]	Horizontal/Vertical compensation [mm]
GA 43.10.55 S	89	max 65	214	55	Aluminum, PVC, steel	300	20(±10)

CONECTO GA 43.10.55 S
VIEW

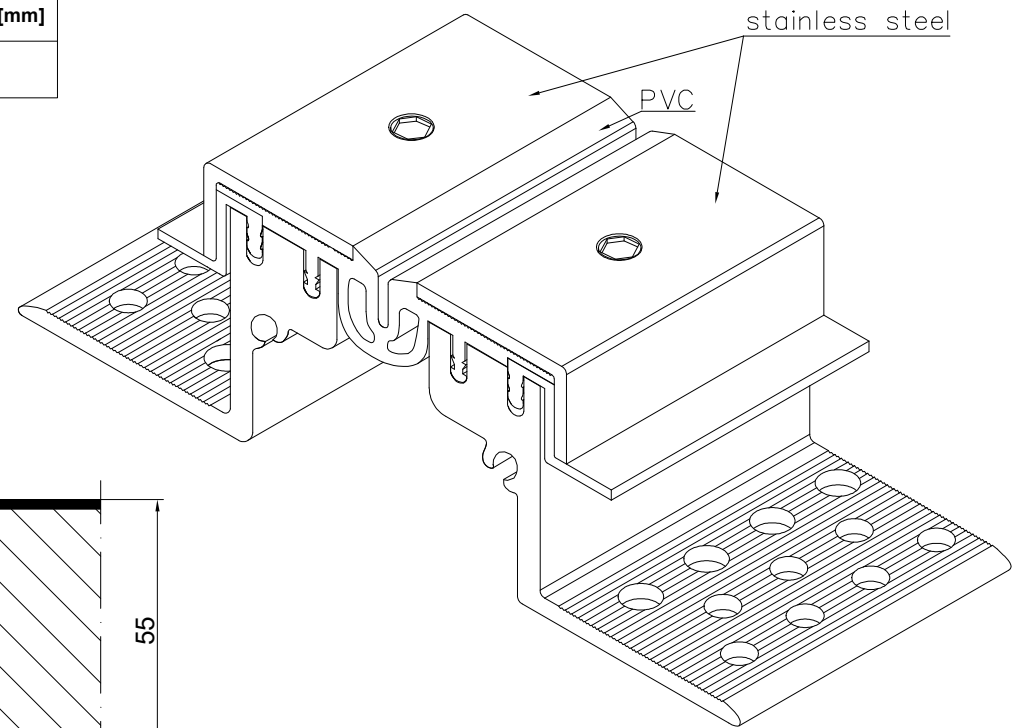

CONECTO GA 43.10.55 S
SECTION

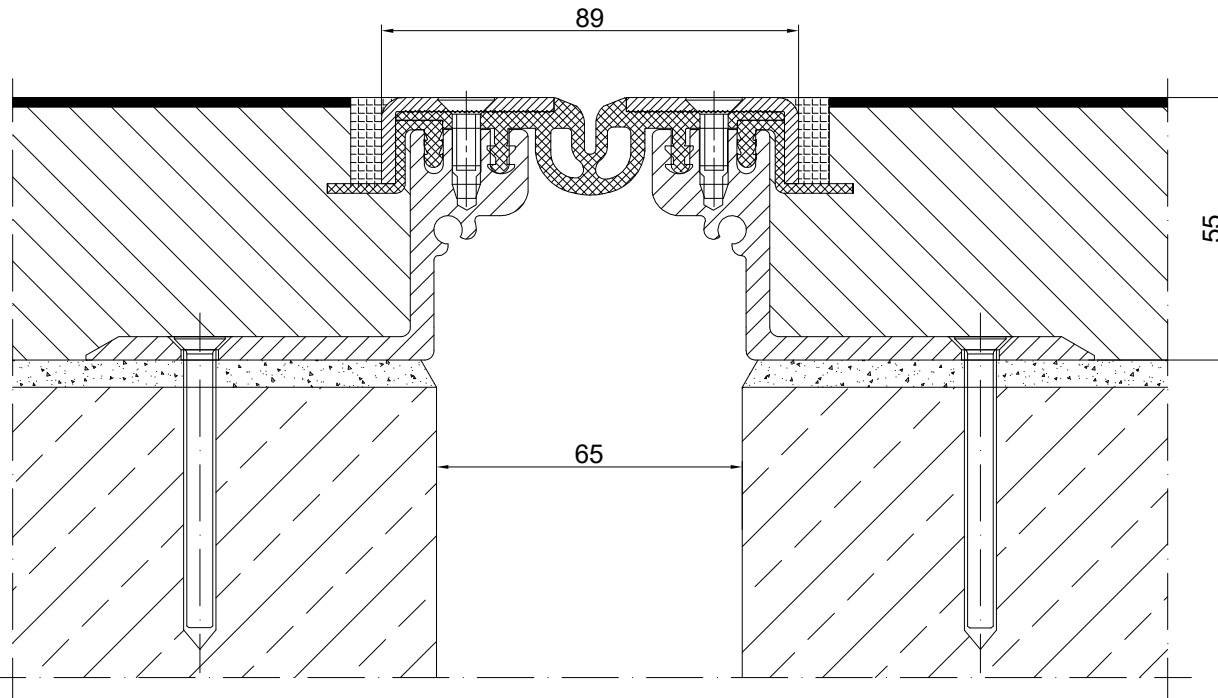

Expansion joint Conecto Park
GA 43.10.55 S

Conecto Profiles Sp. z o.o.
ul. Przemysłowa 39
61-541 Poznań
www.conecto-profiles.com



ROZMIAR / SIZE A3	SKALA / SCALE 1:1	Wszystkie wymiary podano w [mm] All dimensions in [mm]
----------------------	----------------------	---

PROJEKT	PROJECT	ZŁOŻENIE	SUB ASSEMBLY	RYSUNEK	DRAWING	ARKUSZ	SHEET	WER	REV
--	--	--	--	01	01	1	Z OF	1	