

INFORMATION TABLE

Profile type	Visible element [mm]	Joint width [mm]	Base width [mm]	Installation height [mm]	Material type	Maximum load [kN]	Horizontal/Vertical compensation [mm]
EL 50.8.10	50	50	175	10	Aluminum, modified PVC	30	16(±8) 16(±8)

CONECTO EL 50.8.10 SECTION

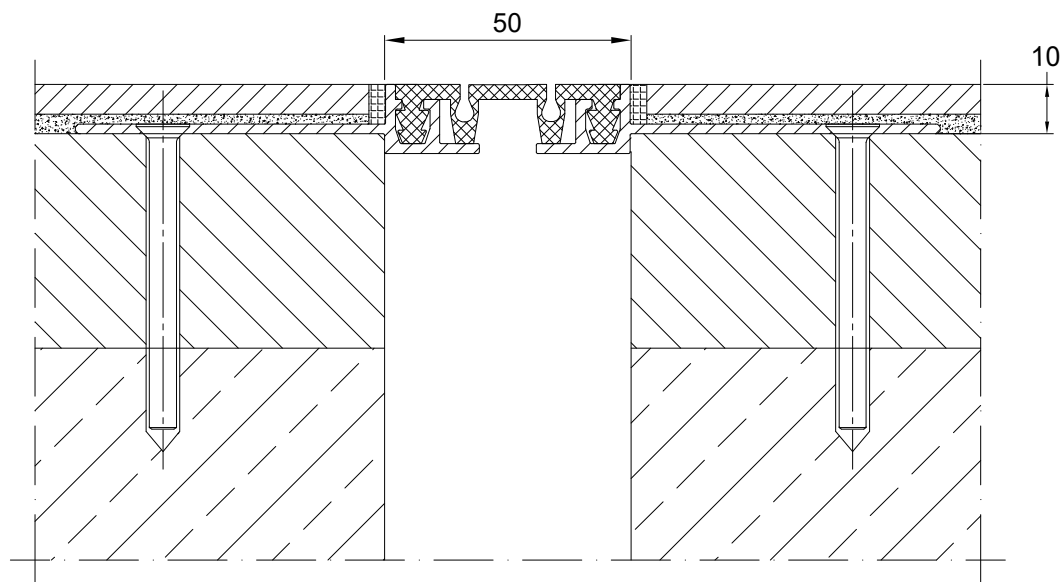

CONECTO EL 50.8.10 VIEW

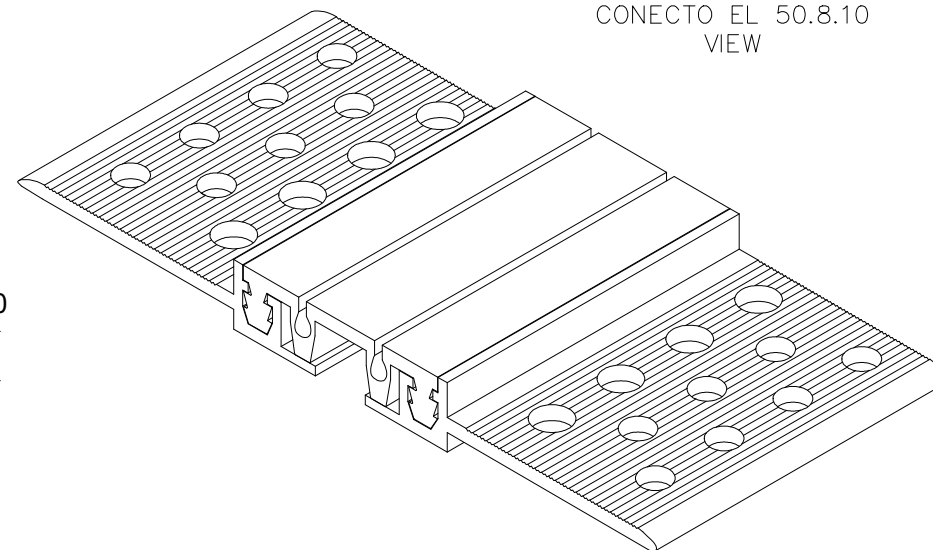

Expansion joint Conecto Elasto 50.8.10

Conecto Profiles Sp. z o.o.
ul. Przemysłowa 39
61-541 Poznań
www.conecto-profiles.com



ROZMIAR / SIZE
A3

SKALA / SCALE
1:1

Wszystkie wymiary podano w [mm]
All dimensions in [mm]

PROJEKT	PROJECT	ZŁOŻENIE	SUB ASSEMBLY	RYSUNEK	DRAWING	ARKUSZ SHEET	WER REV
--		--		01		1 Z OF 1	