

INFORMATION TABLE

Profile type	Visible element [mm]	Joint width [mm]	Base width [mm]	Installation height [mm]	Material type	Maximum load [KN]	Horizontal/vertical compensation [mm]
AL 125.20.87	125	max 90	230	87	Aluminum	70	40(±20) -30 / +24

CONECTO AL 125.20.87
SECTION
SCALE 1:2

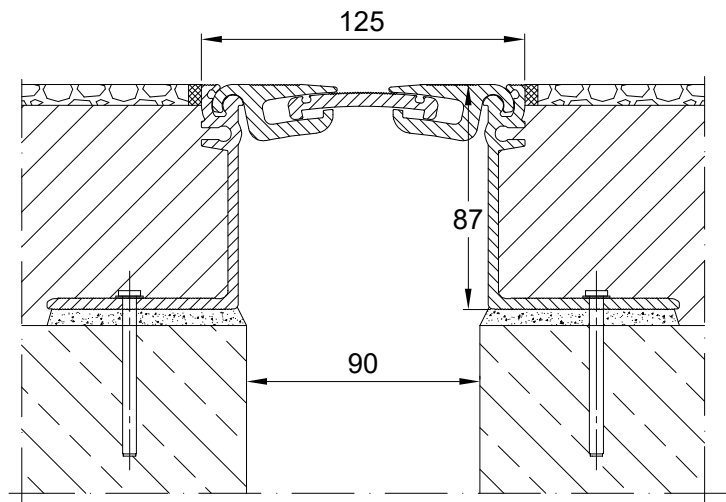

CONECTO AL 125.20.87
VIEW

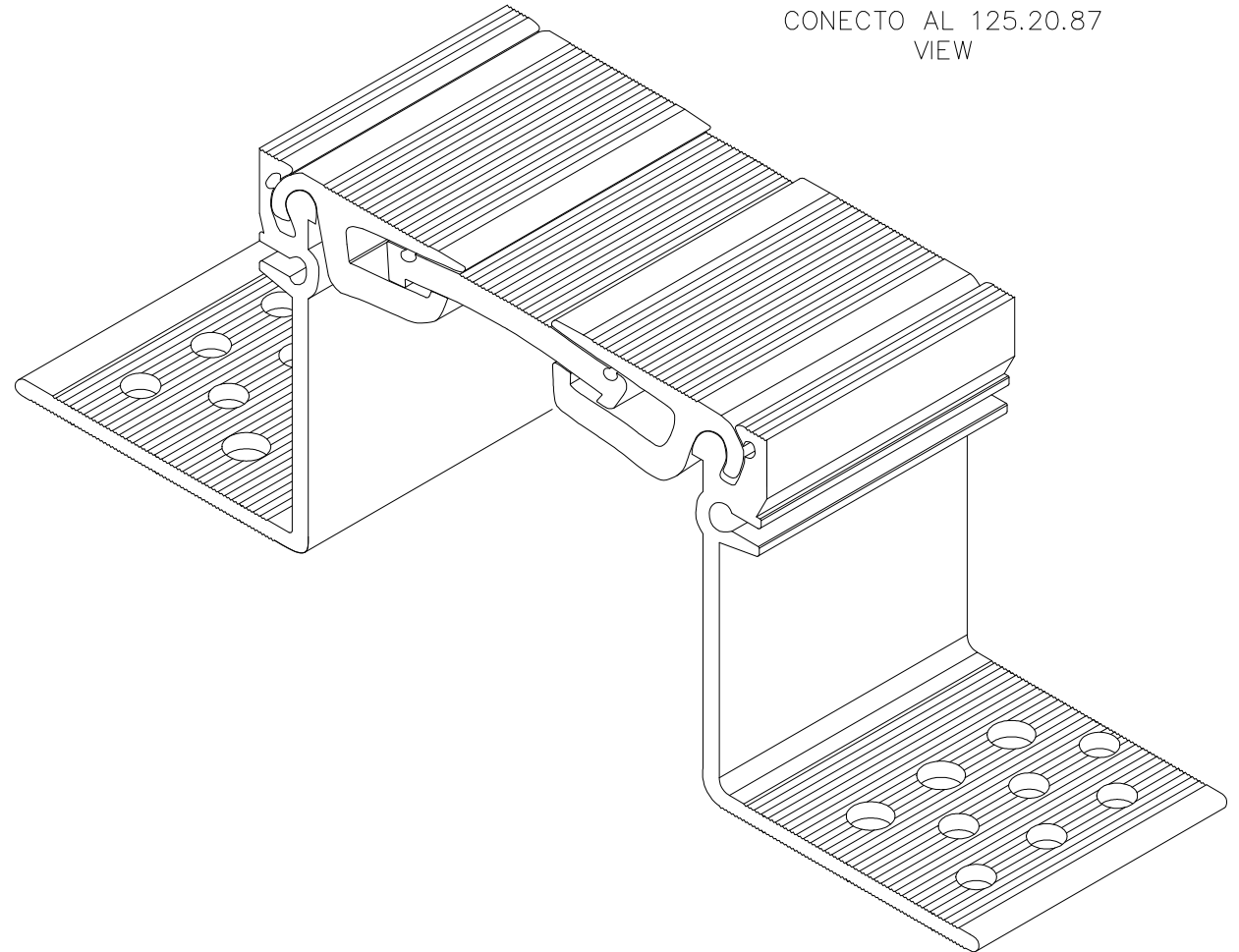

Expansion joint Conecto
AL 125.20.87

Conecto Profiles Sp. z o.o.
ul. Przemysłowa 39
61-541 Poznań
www.conecto-profiles.com



ROZMIAR / SIZE A3	SKALA / SCALE 1:1	Wszystkie wymiary podano w [mm] All dimensions in [mm]
----------------------	----------------------	---

PROJEKT	PROJECT	ZŁOŻENIE	SUB ASSEMBLY	RYSUNEK	DRAWING	ARKUSZ	SHEET	WER	REV
--	--	--	--	01	01	1	Z OF	1	